

Compact Disc Player

Operating Instructions



CDP-C445

Warning

To prevent fire or shock hazard, do not expose the unit to rain or moisture.

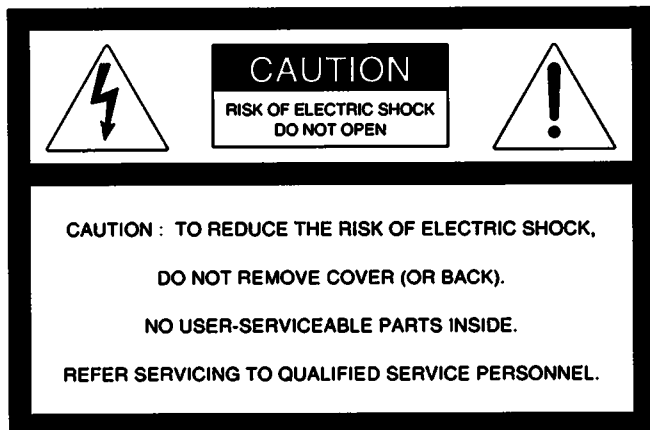

This symbol is intended to alert the user to the presence of uninsulated "dangerous voltage" within the product's enclosure that may be of sufficient magnitude to constitute a risk of electric shock to persons.



This symbol is intended to alert the user to the presence of important operating and maintenance (servicing) instructions in the literature accompanying the appliance.

INFORMATION

This equipment has been tested and found to comply with the limits for a Class B digital device, pursuant to Part 15 of the FCC Rules. These limits are designed to provide reasonable protection against harmful interference in a residential installation. This equipment generates, uses, and can radiate radio frequency energy and, if not installed and used in accordance with the instructions, may cause harmful interference to radio communications. However, there is no guarantee that interference will not occur in a particular installation. If this equipment does cause harmful interference to radio or television reception, which can be determined by turning the equipment off and on, the user is encouraged to try to correct the interference by one or more of the following measures.

- Reorient or relocate the receiving antenna.
- Increase the separation between the equipment and receiver.
- Connect the equipment into an outlet on a circuit different from that to which the receiver is connected.
- Consult the dealer or an experienced radio/TV technician for help.

You are cautioned that any changes or modifications not expressly approved in this manual could void your authority to operate this equipment.

Owner's Record

The model and serial numbers are located at the rear. Record the serial number in the space provided below. Refer to these numbers whenever you call upon your Sony dealer regarding this product.

Model No. _____ Serial No. _____

For the Customers in Canada

CAUTION
TO PREVENT ELECTRIC SHOCK, DO NOT USE THIS POLARIZED AC PLUG WITH AN EXTENSION CORD, RECEPTACLE OR OTHER OUTLET UNLESS THE BLADES CAN BE FULLY INSERTED TO PREVENT BLADE EXPOSURE.

This apparatus complies with the Class B limits for radio noise emissions set out in Radio Interference Regulations.

For the Customers in Australia

The following caution label is located inside of the unit.

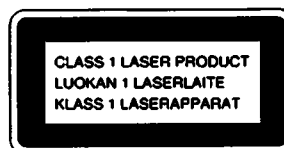
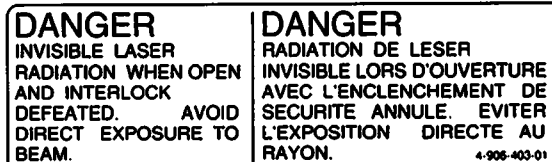

This appliance is classified as a CLASS 1 LASER product. The CLASS 1 LASER PRODUCT MARKING is located on the rear exterior.

Note when moving the player

Before moving the player, follow the procedure below to return the internal mechanisms back to their original position.

- 1 Remove all of the discs from the disc tray.
- 2 Press the OPEN/CLOSE button to close the disc tray. Make sure that the "no disc" indication lights up in the front panel display.
- 3 Wait for 10 seconds, then press the POWER button to turn the player off.

Table of Contents

Chapter 1 Introduction	
Precautions	3
Chapter 2 Getting Started	
Unpacking	4
Hooking Up the System	5
Identifying the Parts	6
Chapter 3 Basic Operation	
Playing Discs – Continuous Play	8
Playing From the First Selection	8
Information Display	9
Locating a Particular Selection	10
Locating a Particular Point in a Selection	10
Replacing Discs While Playing a Disc	11
Fade-In/Fade-Out	12
Playing in a Random Order – Shuffle Play	13
Playing in a Specified Order – Program Play	14
Playing the Beginning of Each Selection	
– Music Scan Play	17
Playing Repeatedly – Repeat Play	18
Chapter 4 Advanced Operation	
Locating the Loudest Portion of the Disc – Peak Search ...	19
Specifying the Total Playing Time – Time Edit	20
Fading Out at the Desired Time – Time Fade	22
Storing Selections You Want to Play – Delete Bank	23
Chapter 5 Additional Information	
Maintenance	25
Specifications	25
Troubleshooting	26

Convention



This indicates a function operated only from the main unit.

Chapter 1 Introduction

Precautions

On safety

- Should any solid or liquid object enter the cabinet, unplug the unit and have it checked by qualified personnel before operating it any further.
- Unplug the unit from the wall outlet if it is not to be used for an extended period of time. To disconnect the cord, pull it out by the plug. Never pull the cord itself. The unit is not disconnected from the AC power source (mains) as long as it is connected to the wall outlet, even if the unit itself has been turned off.
- The AC power cord must be changed only at the qualified service shop.
- As the laser beam used in this unit is harmful to the eyes, do not attempt to disassemble the cabinet. Refer servicing to qualified personnel only.

On operation

- Do not turn up the volume while listening to a portion with no audio signals or very low level inputs. If you do, the speakers may be damaged when a peak level portion is played.

On the disc tray

- If the disc tray does not close properly and slides out again, reinsert the discs.
- Be careful not to pinch your fingers between the disc tray and the unit.
- Place only one disc in a disc compartment at a time.
- When the disc tray is open, do not press down on it forcibly, nor place a heavy object on it.

On moisture condensation

If the unit is brought directly from a cold to a warm location, or is placed in a very damp room, moisture may condense on the lens inside the unit. Should this occur, the unit will not operate. In this case, remove the disc and leave the unit turned on for about an hour until the moisture evaporates.

Notes on handling discs

- To keep a disc clean, handle the disc by its edge. Do not touch the surface.



- Do not stick paper or tape on the disc.



- Do not expose the disc to direct sunlight or heat sources such as hot air ducts, or leave it in a car parked in direct sunlight as the heat may cause the disc to warp.
- After playing, store the disc in its case.

If you have any questions or problems concerning your player, please contact your nearest Sony dealer.

For the Customers in the U.S.A.

For detailed safety precautions, see the leaflet "IMPORTANT SAFEGUARDS".

Unpacking

Choosing a Good Location

- Place the player in a location with adequate air circulation to prevent internal heat built up in the player.
- Do not place the player on a soft surface, such as a rug that would block the ventilation holes on the bottom.
- Do not install the player:
 - near heat sources such as radiators or air ducts.
 - in a place subject to direct sunlight, excessive dust, mechanical vibration or shock.

Checking the Supplied Accessories

Make sure that all the supplied accessories are included with your player. This manual and the following items are included with your CDP-C445.

Remote commander
RM-D335 (1)

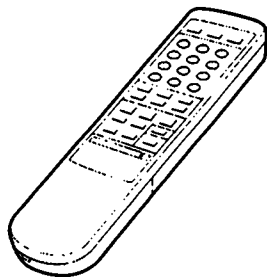

Sony batteries
SUM-3(NS) (2)

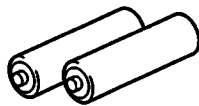

Audio connecting cord (1)



Inserting Batteries into the Remote Commander

1 Slide open the cover.

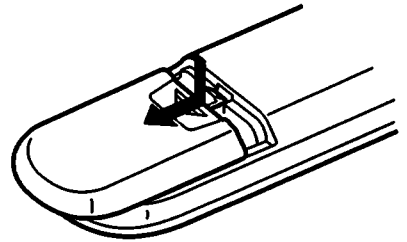

2 Insert two size AA (R6) batteries with correct polarity.

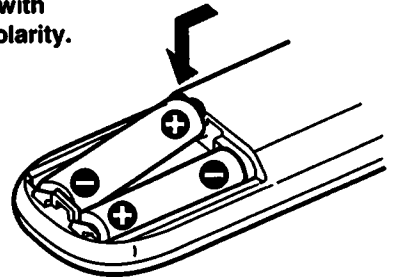

Battery life

- About half a year of normal operation can be expected when using the Sony batteries SUM-3(NS).
- When the batteries are run down, the remote commander will not operate the player. In this case, replace both batteries with new ones.

Notes on remote commander operation

- Avoid exposing the remote sensor to direct sunlight or a lighting apparatus. Such exposure may cause a malfunction.
- To avoid damage caused by battery leakage and corrosion, remove the batteries when the commander will not be used for a long time.

Hooking Up the System

Notes on Connection

- Turn off the power to each unit before making connections. Connect the AC power cord last.
- Be sure to insert the plugs firmly into the jacks. Loose connections may cause hum or noise.
- Leave a little slack in the connecting cord to allow for inadvertent shock or vibration.
- Cord plugs and jacks are color coded: Red plugs and jacks are for the right channel (R) and white ones for the left channel (L).

Connecting an Amplifier

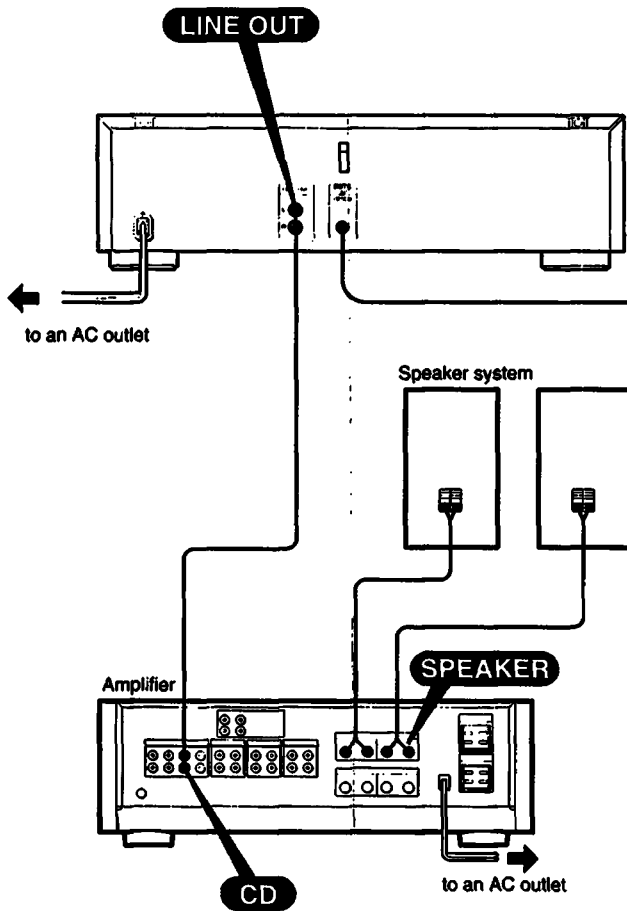

Using DIGITAL OUT (OPTICAL)

When connecting to an amplifier or D/A converter with OPTICAL IN, connect the OPTICAL IN and the DIGITAL OUT (OPTICAL) on the player with the POC-15 Audio Fiber Optical Cable (not supplied).



Take off the cap

Plug in firmly

Notes on DIGITAL OUT (OPTICAL)

- When using the DIGITAL OUT (OPTICAL), fade out, fade in and time fade functions do not work.
- Noise may occur when playing non-music discs.

Identifying the Parts

Front Panel

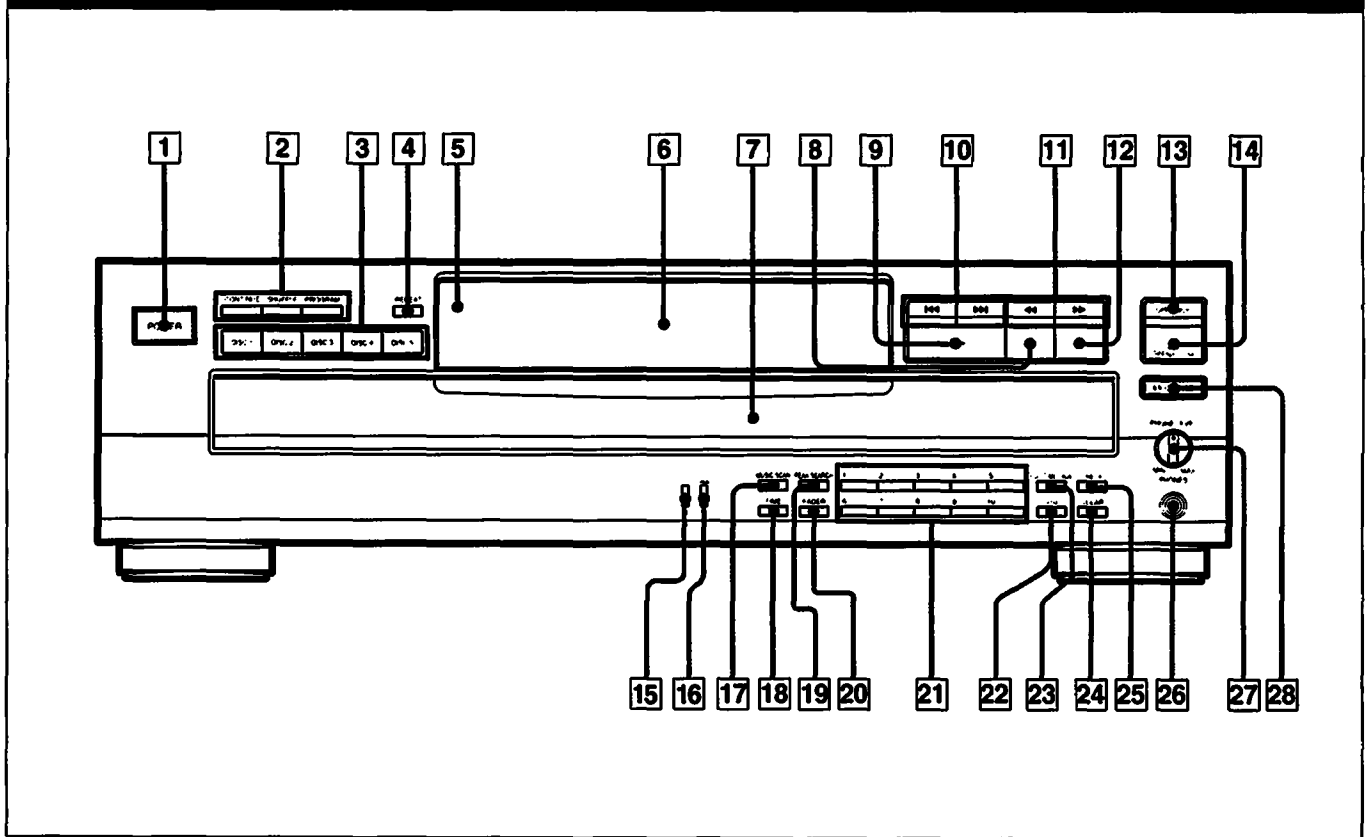

See the pages indicated in () for details.

- 1** POWER switch (8)
- 2** PLAY MODE buttons
CONTINUE button (8)
SHUFFLE button (13)
PROGRAM button (14)
- 3** DISC 1-5 buttons (8)
- 4** REPEAT button (18)
- 5** Remote sensor (4)
- 6** Display window (8)
- 7** Disc tray (8)
- 8** || (pause) button (8)
- 9** ► (play) button (8)
- 10** ◀◀▶▶ (AMS*) buttons (10)
- 11** ◀◀▶▶ (manual search) buttons (10)
- 12** ■ (stop) button (8)
- 13** DISC SKIP button (8)
- 14** ▲ OPEN/CLOSE button (8)

- 15** FILE button (23)
- 16** ERASE button (24)
- 17** MUSIC SCAN button (17)
- 18** TIME button (9)
- 19** PEAK SEARCH button (19)
- 20** FADER button (12)
- 21** Numeric buttons (10)
- 22** >10 (over 10) button (10)
- 23** EDIT/TIME FADE button (20)
- 24** CLEAR button (14)
- 25** CHECK button (16)
- 26** PHONES jack (9)
- 27** PHONE LEVEL control (9)
- 28** EX-CHANGE button (11)

* AMS is the abbreviation for Automatic Music Sensor.

Remote Commander

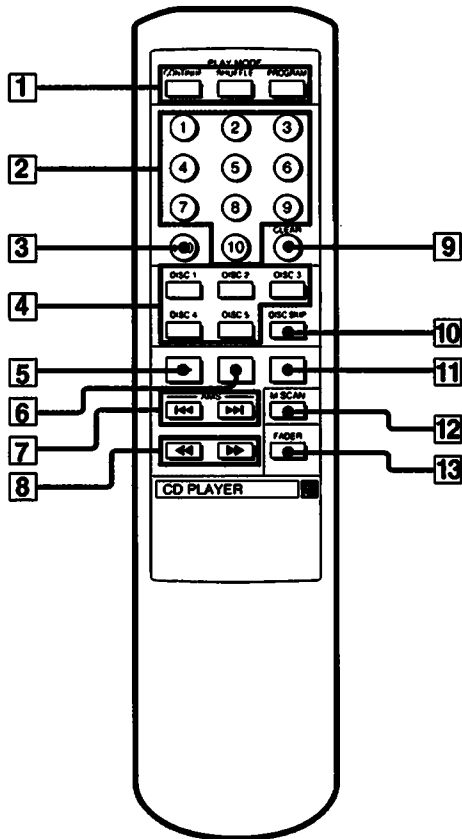

See the pages indicated in () for details.

- 1** PLAY MODE buttons
 - CONTINUE button (8)
 - SHUFFLE button (13)
 - PROGRAM button (14)
- 2** Numeric buttons (10)
- 3** >10 (over 10) button (10)
- 4** DISC 1-5 buttons (8)
- 5** ▶ (play) button (8)
- 6** ■ (pause) button (8)
- 7** ◀▶/▶▶ (AMS) buttons (10)
- 8** ◀▶/▶▶ (manual search) buttons (10)
- 9** CLEAR button (14)
- 10** DISC SKIP button (8)
- 11** ■ (stop) button (8)
- 12** M. SCAN (MUSIC SCAN) button (17)
- 13** FADER button (12)

Playing Discs – Continuous Play

In continuous play mode, you can play up to five discs consecutively. Before playing discs, turn on the amplifier and set the input selector to the CD player position. While playing a disc, you can replace the other four discs in the player with new ones using the EX-CHANGE button.

Playing From the First Selection

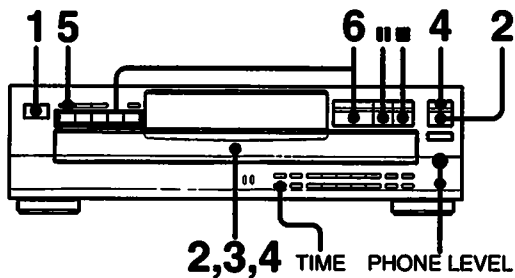

1 Press POWER.



The display lights up.

2 Press \triangle .

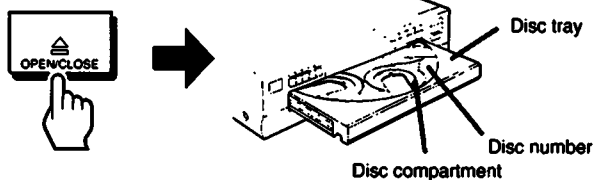

3 Place a disc with the label side up in the disc compartment.

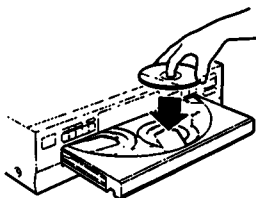

- To play more than one disc, go to step 4.
- To play only one disc, go to step 5.

4 Press DISC SKIP to set the next empty disc compartment and place another disc in it.

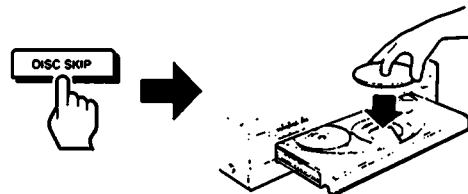

5 Press CONTINUE to select ALL DISCS or 1 DISC.

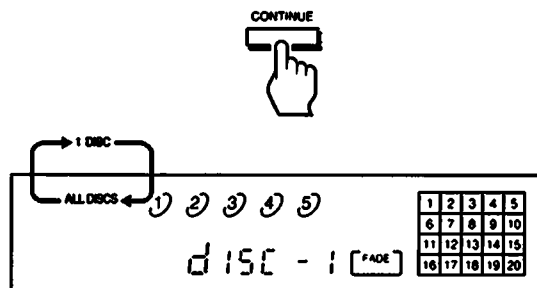

Each time you press CONTINUE, the indication ALL DISCS and 1 DISC alternate in the display.

6 Press \blacktriangleright or DISC 1-5.

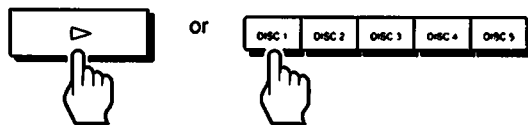

The disc tray closes to start playing the first selection.

- If you press \blacktriangleright , the disc in the front loading position starts playing.
- If you press one of the DISC 1-5 buttons, the selected disc starts playing.

To stop play

To pause during play, press \mathbb{I} .

Press \blacktriangleright or \mathbb{I} to resume play.

To stop play, press \blacksquare .

To stop play and open the tray, press \triangle .

To select the disc from which the playing starts

There are two ways.

- To scan discs, press or hold down DISC SKIP.
- To select a particular disc directly, press the corresponding DISC 1-5 button.

Notes on ALL DISCS and 1 DISC

- If you choose ALL DISCS, all the discs in the player are played consecutively. An empty disc compartment is skipped.
- If you choose 1 DISC, only one disc is played.

Notes on disc tray

- Place a disc in the empty disc compartment only when it is in the front loading position. Otherwise, the player may not be able to find the disc.
- Always close the disc tray when not using the player to prevent dust from entering the unit.
- Place the disc properly in the disc compartment to prevent the disc from being damaged.

When listening with headphones

Connect the headphones to the PHONES jack and adjust the volume with the PHONE LEVEL control on the player.

To play an 8 cm (3-inch) CD

Place it in the inner circle in the disc compartment. If the disc is provided with an adaptor, first remove it. Do not put a normal CD (12cm/5-inch) on top of an 8 cm (3-inch) CD.

Information Display

Checking the total number of selections and total playing time of the disc to be played.

There are two ways to check.

- Place the disc in the disc compartment in the front loading position, then press Δ or the disc tray itself to close it.
- Press TIME on the player during stop. To check another disc, press DISC SKIP, then press TIME.

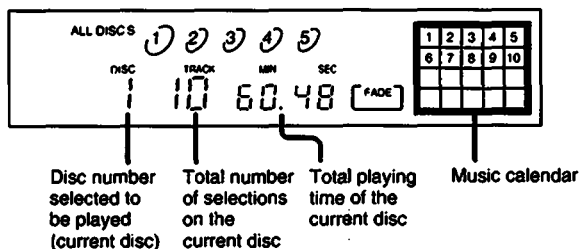

Notes on "1 2..." in the display

- The red circle around a disc number indicates the disc is ready to be played. The red circle moves each time you press DISC SKIP.
- When all the selections on a disc have been played, the semi-circle around the disc number disappears.
- When a compartment is recognized as empty, the semi-circled disc number disappears.

Changing the display

Each time you press TIME during play, the display changes to give you the following information:

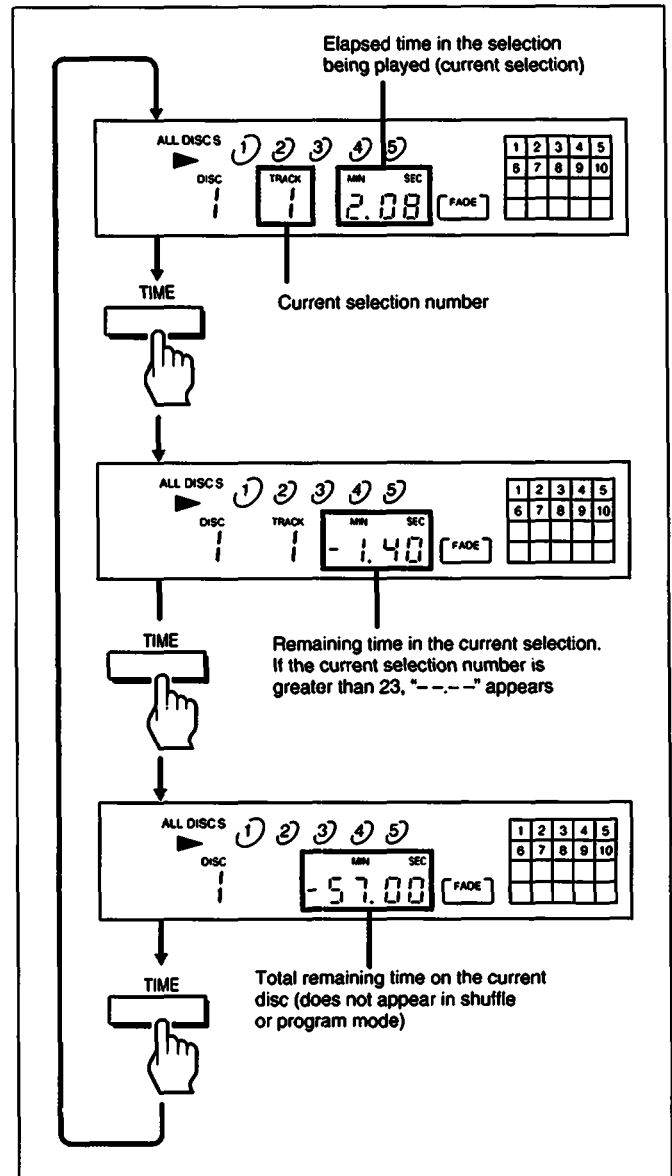

Notes on the information display

- Total remaining time is only available in the continuous play mode.
- Total remaining time will appear if the time fade function is set during program or shuffle play.

What is this indication?

no disc

This indication appears when all disc compartments are empty.

Playing Discs

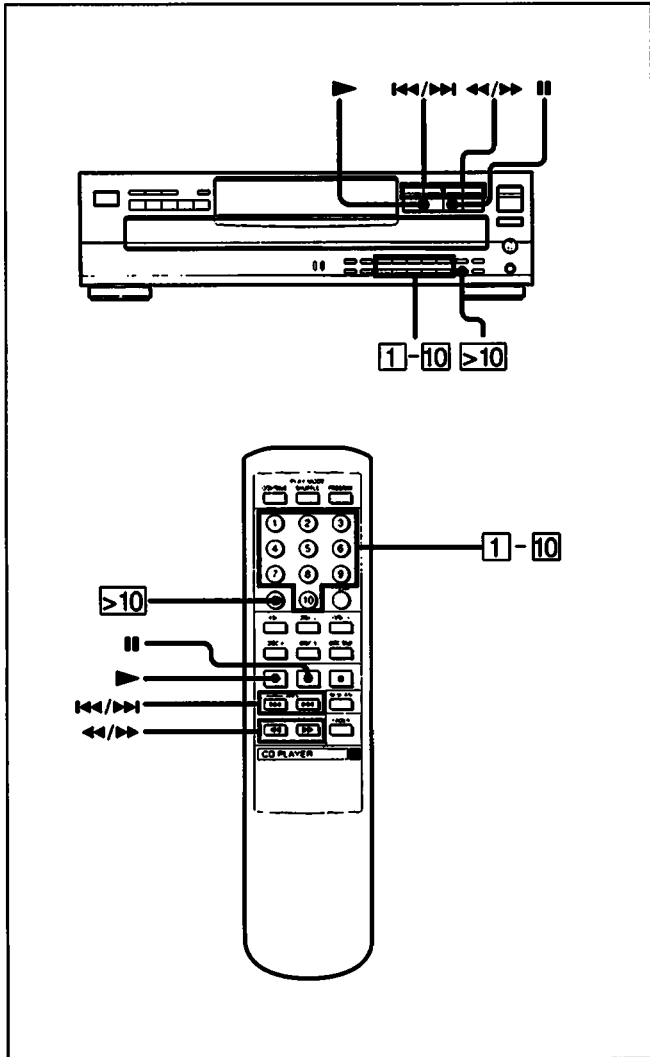

Locating a Particular Selection

There are two ways to locate the beginning of a desired selection on the current disc.

A. To locate sequentially (Automatic Music Sensor)

- Press **⏮** once to locate the beginning of the current selection.
- Press **⏭** once to locate the beginning of the next selection.
- Hold down **⏮** or **⏭** to skip selections.

B. To locate a selection directly

Press one of the numeric buttons on the player or remote commander to enter the desired selection.

To enter a number greater than 10, use the **>10** and **1** to **10** buttons.

Example:

To play from selection No.22

Press **>10** **2** **2**.

To play from selection No.30

Press **>10** **3** **10**.

10 functions as the number 0.

Locating a Particular Point in a Selection

There are two ways to locate a desired point on a disc.

A. To locate a point on the current disc while monitoring the sound

Hold down **⏮** or **⏭** during play.

B. To locate a point on the current disc quickly by watching the display

Press **⏸**, then hold down **⏮** or **⏭**. The search speed will increase, but there will be no sound. Find the desired point by watching the display.

Press **⏸** or **⏭** again at the desired point to resume play.

"⏮" appears in the display

If you continuously press **⏭** during play at the end of the disc, "⏮" appears in the display. Press **⏮** or **⏮** to return to the normal display.

Replacing Discs While Playing a Disc

To replace discs while playing a disc, use the EX-CHANGE button. You can open the disc tray and check what discs are to be played next, or replace discs without interrupting playback of the current disc.

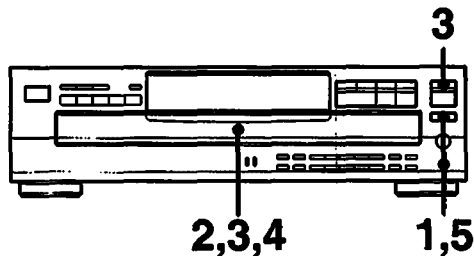

1 Press EX-CHANGE.

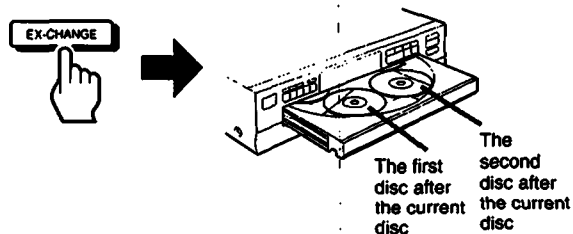

If you are playing a disc, it continues to play.

2 Replace discs in the compartments with new ones.

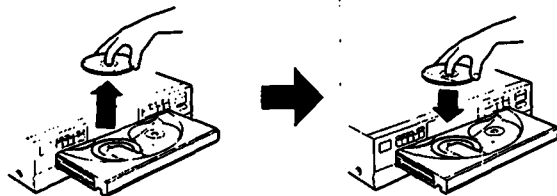

You can replace up to two discs at a time.

3 Press DISC SKIP.

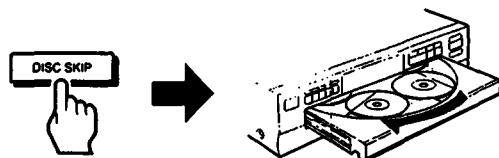

The disc tray turns and another two disc compartments appear.

4 Replace discs in the compartments with new ones.

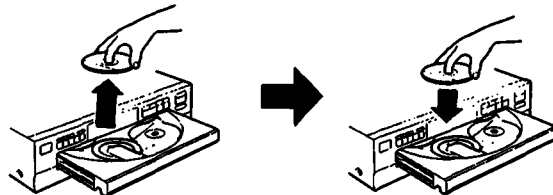

5 Press EX-CHANGE.



The disc tray closes and playback continues.

Notes on EX-CHANGE

- Each time you press DISC SKIP while the disc tray is open, the disc tray turns and two pairs of the disc compartments appear alternately, but the compartment for the disc currently played does not appear to avoid two discs being placed in one disc compartment.
- Do not turn the disc tray forcibly.
- You can use almost all of the functions to play the current disc while the disc tray is open.
- If playback of the current disc ends while the disc tray is open, the player stops playing. In one disc repeat mode, the current disc starts playing again.
- In ALL DISCS shuffle mode, selections are reshuffled on the current disc while the disc tray is open.
- In program mode, only the selections on the current disc are played.

When you open the disc tray by pressing EX-CHANGE
Do not push the disc tray to close it as you may damage the player.

Fade-In/Fade-Out

Fading in and out allows you to record selections on your tape in such a manner that play starts and stops gradually. Fade-in/out cannot be done when you use the DIGITAL OUT (OPTICAL) connection.

Fading

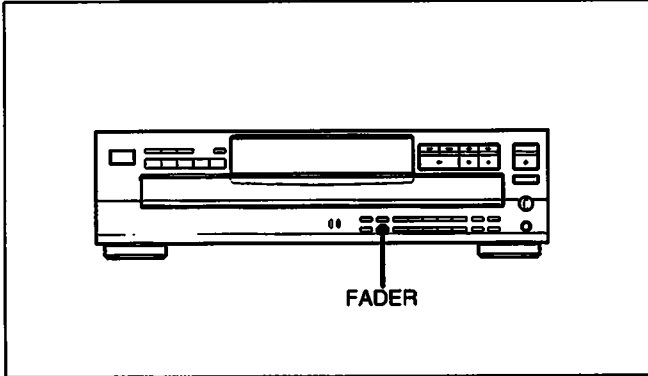

To fade out

Press FADER during play at the point you want to start fading out. "[FADE]" flashes in the display, play fades out and the player enters pause mode.

To fade in

Press FADER during pause.

"[FADE]" flashes in the display, and play fades in.

Changing the Fade Time

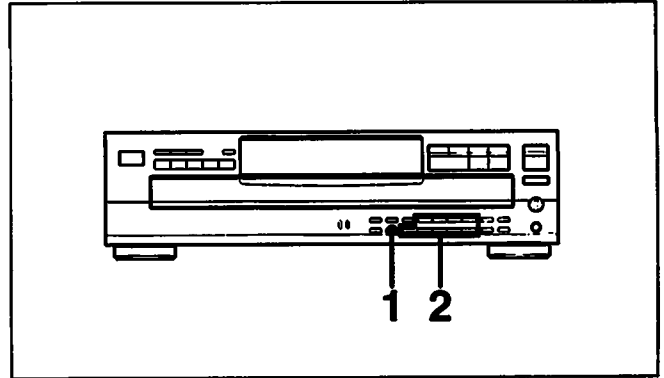

You can vary the fading time from 2 to 10 seconds while the player is stopped. When a time is not specified, play will fade in and fade out for 5 seconds.

1 Press FADER during stop.

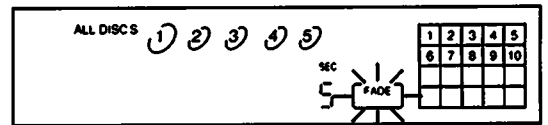

"[FADE]" flashes and the actual fade time appears.

2 Press [2] - [10] to select fade time.

Example:

To set to 8 seconds, press [8].

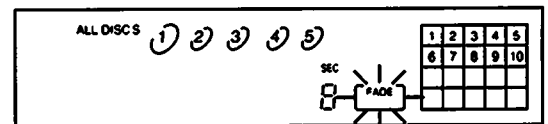

Playing in a Random Order – Shuffle Play

Shuffle play allows you to play up to 99 selections in a random order. You can play selections from all discs or only specified loaded disc(s).

Shuffle Play on All or One Disc

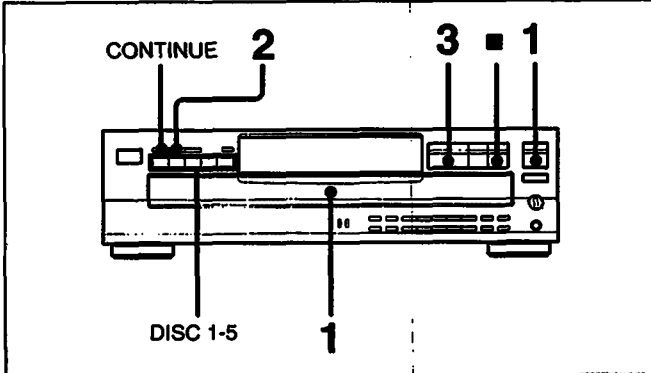

1 Place the discs in the disc compartments.

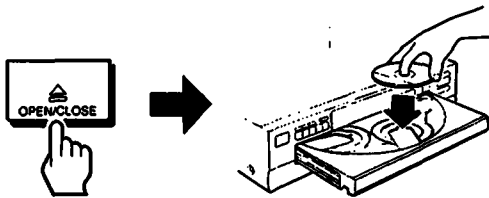

2 Press SHUFFLE to choose ALL DISCS or 1 DISC.

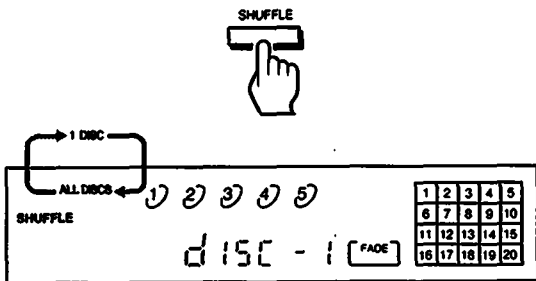

- ALL DISCS: The selections from all discs are played in a random order.
- 1 DISC: The selections from the current disc are played in a random order.

3 Press ►.

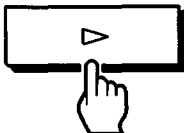

Shuffle play starts.
In 1 DISC mode, you can also use DISC 1-5.

To stop play

Press ■.

To cancel shuffle play

Press CONTINUE to return to continuous play mode.

If you press SHUFFLE during continuous or program play
Shuffle play begins from the current selection.

What is this indication?



This indication appears while the player is "shuffling" the selections.

Shuffle Play on Specified Discs – Select Shuffle Play

If you specify discs before or during play in ALL DISCS shuffle mode, the selections on the specified discs only will play in a random order.

To specify the discs

- 1) Press DISC 1-5 to specify the discs after choosing ALL DISCS mode.
Semi-circles appear around the selected discs, press DISC 1-5 again. The semi-circles disappear.
- 2) Press ► to start select shuffle play.
The selections on the specified discs are played in a random order.

To return to all shuffle play

Press SHUFFLE twice.

Playing in a Specified Order – Program Play

Program play allows you to specify the order of discs or selections to be played. You can program up to 32 "steps" in the order you specify. One "step" may contain one selection or a whole disc. You can check the total playing time while programming the selections.

Program Play

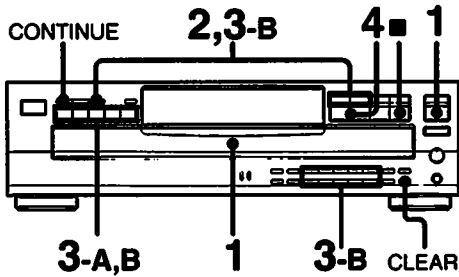

- 1** Place discs in the disc compartments, then press **▲**.

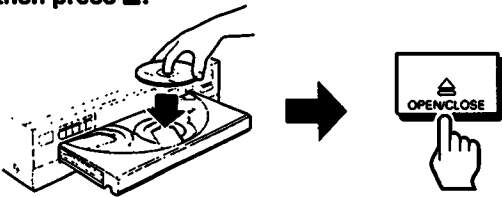

- 2** Press **PROGRAM**.



"PROGRAM" appears in the display.
 - If a program has been previously stored, it is recalled. If you do not need the program, hold down **CLEAR** to erase it (page 15).

- 3-A** To program discs in the order you want play
 Press **DISC 1-5** in the order you want to program.

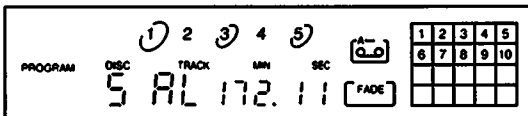

"AL" appears in the display.
 - If you use **DISC SKIP** instead of **DISC 1-5** to choose the disc, press **PROGRAM** after that.

- 3-B** To program selections on a disc in the order you want to play

Before you program selections, specify the disc by pressing **DISC 1-5**. There are two ways to program selections.

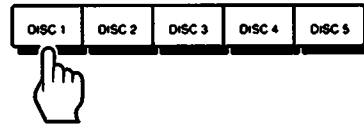

- 1) Use the numeric buttons to choose selections in the order you want to program.

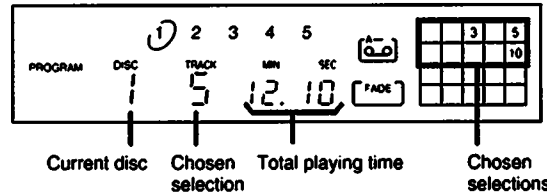
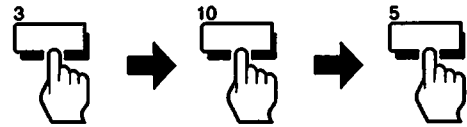

"AL" in the display disappears, then the selections you choose will be programmed. Each time you choose a disc or a selection, the playing time is added to the total playing time. You can check the total playing time while programming.

- To enter a selection number greater than 10, see page 10.
- If you enter the wrong numbers: Each time you press **CLEAR**, the last entered number will be deleted.
- To program the selection(s) on another disc, press **DISC 1-5** to change the disc, then program selections.

3-B

2) Press **◀◀** or **▶▶** to choose a selection to be programmed, then press **PROGRAM**.

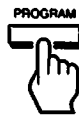
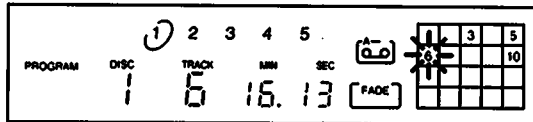
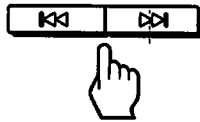

Repeat this to choose another selection.

– Before you press **PROGRAM**, you can check the total playing time and change the selection to be programmed. (Program Edit)

4 Press ▶.

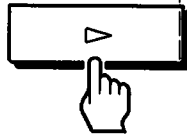

Program play starts.

To erase the program

Hold down **CLEAR** until "ALL CLr" appears in the display.

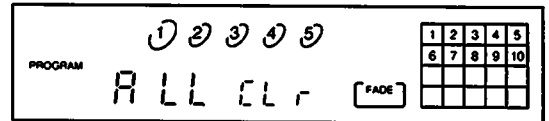

To cancel program play

Press **CONTINUE** to return to continuous play mode. To recall the program you have made, press **PROGRAM** again.

To make a program during play

Press **PROGRAM**, then follow step 3-A or 3-B. The program will be played after the current selection.

If the total playing time does not appear (only "STEP" appears)

You have programmed a selection number greater than 20 or the total playing time exceeds 199 minutes and 59 seconds.

If you press **PROGRAM** during continuous or shuffle play

If a program has been stored, it will be played after the current selection.

If you replace discs

The program is stored until you erase it. If you replace discs, the program operates on the new discs. The selection numbers not existing on the disc are deleted from the program and the rest are played in the programmed order.

If you turn off the player

The program is not erased. It is stored until you erase it.

To stop play

Press **■**.

You can play the same program repeatedly until you erase the program.

Playing in a Specified Order

Recording Programmed Selections

You can make a program to be recorded fit to your tape length. By entering **II**, you can divide a program into side A and B. At the end of a program for side A, the player automatically pauses before side A ends so that a selection is not cut off.

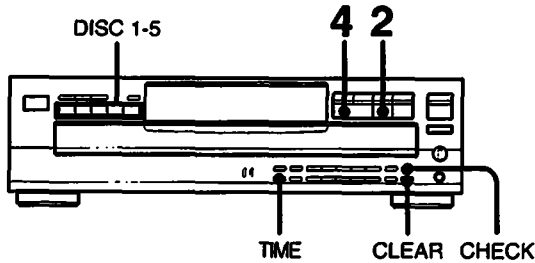

1 Program the selections to be recorded on side A of your tape by repeating steps 1 to 3 on pages 14 and 15.

2 Press **II** to program selections for side B.

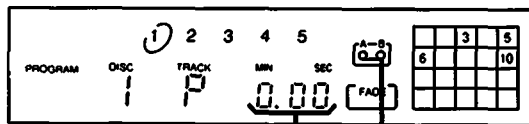

"B" lights up.
Total playing time will return to "0.00".

The selections to be recorded on side A will be programmed.

3 Program the selections for side B.
Repeat steps 1 to 3 on pages 14 and 15.

4 Start recording on the cassette deck, then press **▶**.

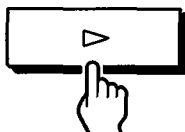

Program play starts.

To play the selections for side B

Play automatically pauses at the point a pause is programmed. Set the tape to the beginning of side B, then press **▶** or **II**. The selections for side B will start playing.

Note

By pressing **II**, a pause is programmed as a selection. The player counts pauses as selections to be programmed.

To check the remaining time

Press **TIME** once to see the remaining time on the current selection; twice to return to the initial display. The total remaining time does not appear during program play.

Checking Your Program

Press **CHECK**. The first selection in the program appears. Each time you press **CHECK**, the next selection in the program appears. One of the tape indicators "A" or "B" appears when the program for side A or B is being played or checked.

Changing Your Program

To delete the last selection

Press **CLEAR** during stop. Each time you press **CLEAR**, the last selection in the program will be deleted.

To delete a selection

Press **CHECK** repeatedly until the selection you want to delete is displayed. Then press **CLEAR**.

To add selections to the end of the program

Press **DISC 1-5** to select the disc and press the numeric buttons for those selections. You can do this during stop, play or pause.

To change the order

Hold down **CLEAR** to erase the program. Then repeat the programming procedure from the beginning.

To make a program by referring to disc labels

You can make a program while the disc tray is open. Follow the steps 2 to 3 on page 14, then 4 on page 15. Program Edit is not available.

Playing the Beginning of Each Selection – Music Scan Play

You can sample the beginning of each selection on a disc. You can also check the beginning of the first selection on each disc loaded. This is useful to check selections in a disc or discs loaded in the player.

Music Scan Play

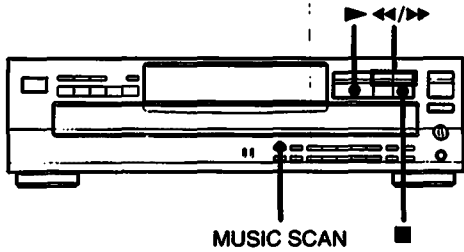

Press MUSIC SCAN.



Each time you press MUSIC SCAN, the playing time of each selection changes cyclically from 10 to 30 seconds.

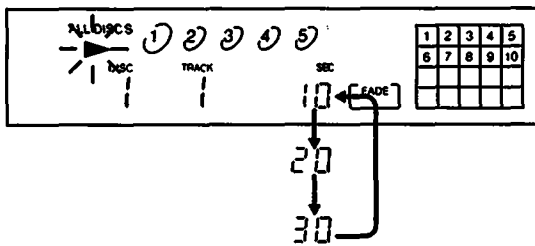

"▶" flashes in the display and the beginning of each selection is played for the designated period.

To check the selections on the current disc
Press MUSIC SCAN in 1 DISC continuous play mode.

To check the first selection on each disc
Press MUSIC SCAN in ALL DISCS continuous play mode.

If you press MUSIC SCAN in program play mode
The beginning of each selection plays in the programmed order. At this time the programmed pauses are ignored.

To stop music scan play
Press ■.

To start play during music scan play
Press ▶. "▶" lights up in the display and normal play starts.

If you press MUSIC SCAN during music scan play
The playing time of the selection is extended by 10, 20 or 30 seconds.

If you press ◀◀ or ▶▶ during music scan
Music scan is cancelled and normal play starts.

Playing Repeatedly – Repeat Play



Repeat play allows you to repeat selections in any play mode. You can repeat all discs, only specified discs, one selection, or programmed or reshuffled selections.

Repeat Play

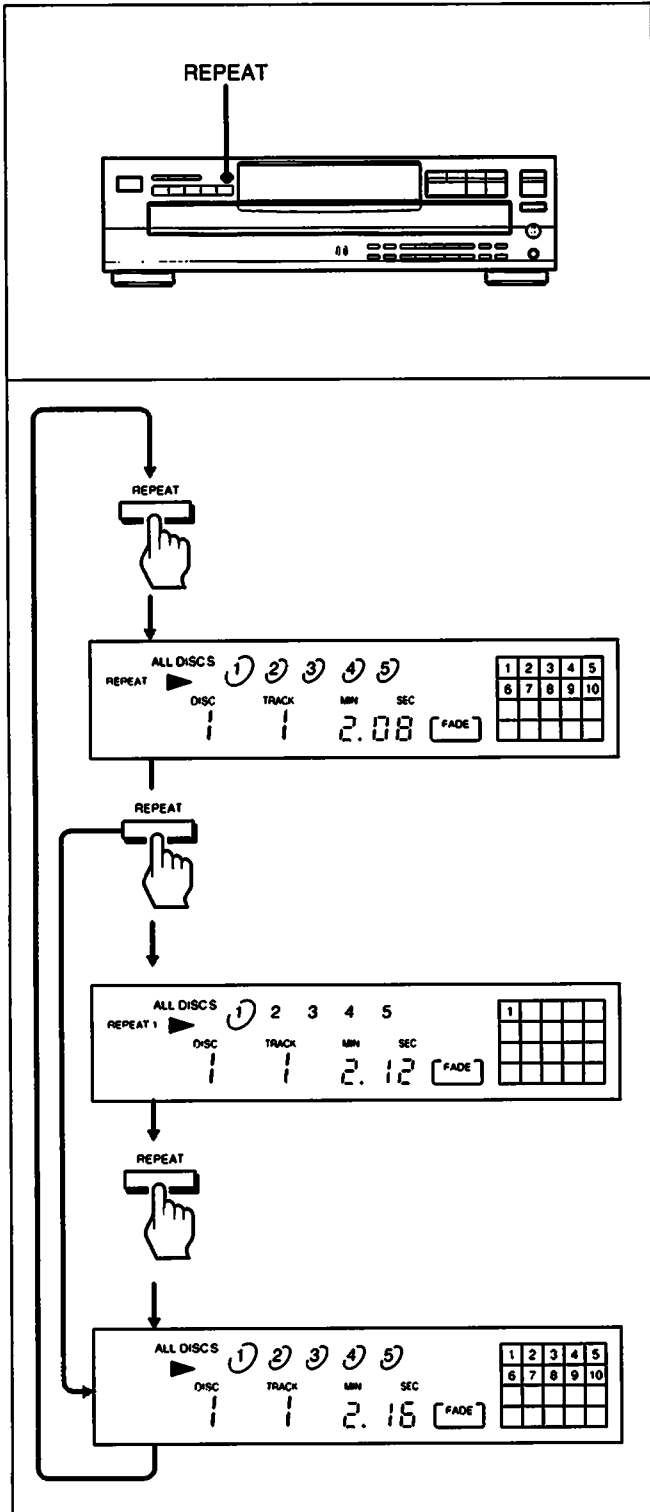

a) To repeat all selections

Press REPEAT once. "REPEAT" appears in the display. The player will repeat in the current play mode.

Playing mode	Selections to be repeated
Continuous play (ALL DISCS)	All selections on all discs
Continuous play (1 DISC)	All selections on the current disc
Shuffle play (ALL DISCS)	Selections on all discs (or selected discs) that the player reshuffles
Shuffle play (1 DISC)	Selections on the current disc that the player reshuffles
Program play	All the selections in the programmed order

b) To repeat the current playing selection (only during continuous play)

Press REPEAT during repeat play. "REPEAT 1" appears in the display. (Not operable during shuffle or program play.)

c) To cancel repeat play

Press REPEAT until "REPEAT" or "REPEAT 1" disappears.

Locating the Loudest Portion of the Disc – Peak Search



You can locate the portion with the highest input level of the disc to adjust the recording level.

Continuous or shuffle play mode

- Searches all selections on the disc which is ready to be played in ALL DISCS as well as in 1 DISC mode.

Program play mode

- Searches all programmed selections.

Playing Peak Search

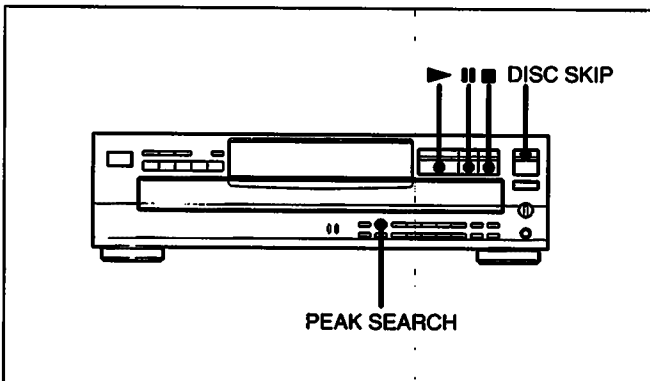

Press PEAK SEARCH during stop.

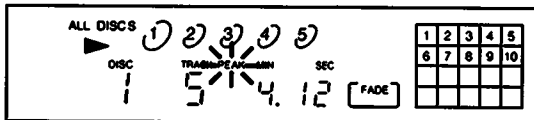

“PEAK” flashes in the display. All the selections in the disc or program will be searched automatically. The loudest portion will play repeatedly for 4 seconds. Adjust the recording level on your tape deck according to the peak level.

To stop peak search

Press ■.

Press ► to start play from the beginning of the disc.

Press II to pause at the first selection.

“PEAK” will disappear from the display.

To go to another disc

Press DISC SKIP during stop.

Notes on Peak Search

- The unit scans input levels of the whole disc and determines the peak (maximum input level) among them. The peak determined with this function is sometimes slightly different from the real one. In addition, portions determined as a peak vary each time this function is carried out on the same disc. The difference between the determined and the real peak is however, negligible and will not prevent you from adjusting the recording level.
- Peak search does not work if you press EX-CHANGE to open the disc tray.

Specifying the Total Playing Time – Time Edit



If you specify the total length of your tape, the player will accordingly program selections to be recorded on sides A and B of your tape. This function edits selections on your tape without changing their original order on your disc, choosing the last selection(s) that fit the remaining length of your tape.

Programming

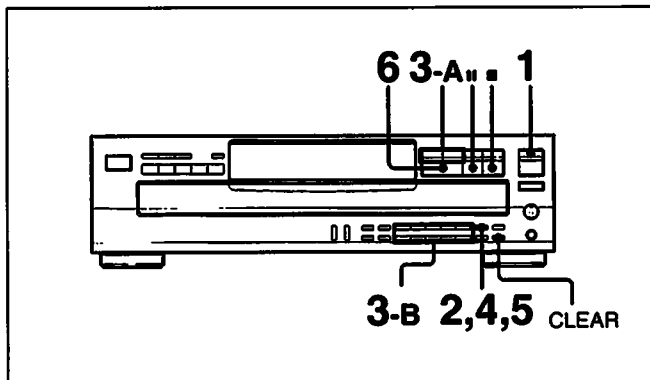

If you want to edit particular selections on your tape in preference to the others, program those selections beforehand (page 14).

1 Press DISC SKIP to select the disc to be played.



2 Press EDIT/TIME FADE.

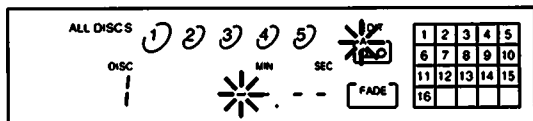

"EDIT" appears and "A" flashes in the display.

3-A Specify a commercially available tape length.

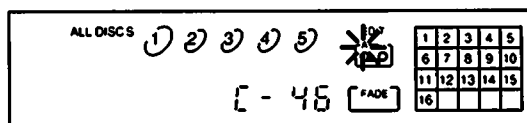
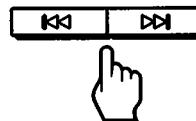

Each time you press **▶▶1**, the display changes to give you the following duration:

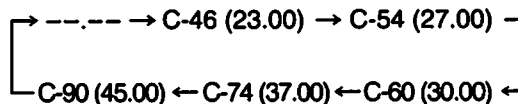

By pressing **1◀◀**, you can reverse the above cycle.

3-B Specify any tape length for one side of your tape.

Use numeric buttons **1** - **10**. Press **10** for "0". You need not press keys for seconds, unless required.

Example:
To set to 23 minutes 15 seconds, press **2**, **3**, **1** and **5**.

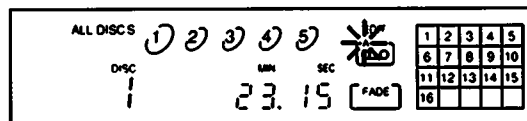
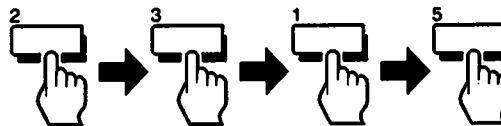

- 4** Press EDIT/TIME FADE once after specifying the recording time.

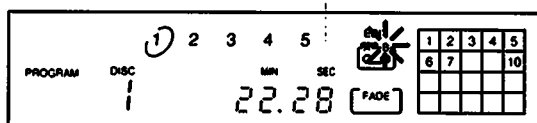

The selections for side A are determined automatically. "EDIT" and "A" light up. "B" flashes.

- 5** Press EDIT/TIME FADE once more, to make a program for the other side of your tape.

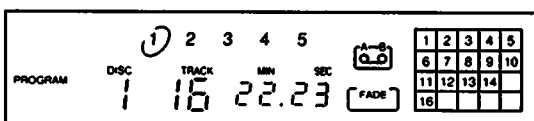

If "LINK" flashes, see "Adding Selection(s) – LINK edit".

- 6** Start recording on the cassette deck, then press ►.

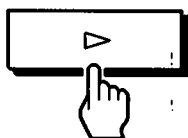

The selections for side A will be played and then the player will pause. "B" lights up in the tape side indicator. Set the tape to the beginning of side B, then press ► or II.

Adding Selection(s) – LINK edit

After all selections on the disc have been programmed, if there is (a) selection(s) shorter than the remaining time, "LINK" and the selection numbers will flash.

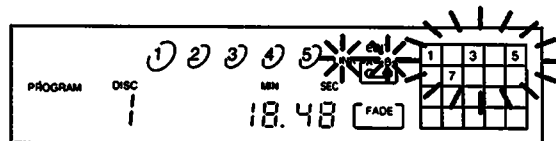

To add a selection, press the numeric button for the selection number or press EDIT/TIME FADE again. When pressing EDIT/TIME FADE, a program will be made automatically to fit the playing time as close as possible to the remaining time. If enough time remains to fit more selections, "LINK" and the selection numbers keep flashing. When "LINK" flashes, if you select another disc using DISC SKIP, the new selection number(s) on the new disc that fit in the remaining time will flash. "EDIT" disappears when the rest of the playing time is less than 1 minute. Whether "LINK" is flashing or not, you can use DISC SKIP to change the disc and choose selection(s) to fit the remaining time. If you do not add any selection(s), press ■. "EDIT" disappears.

To stop play

Press ■.

You can play the same program repeatedly as long as you do not cancel time edit or erase the program.

To cancel time edit

Press CLEAR.

"EDIT" disappears.

To erase the program

Hold down CLEAR until "ALL CLR" appears in the display.

To check your program

See page 16.

If your disc has more than 20 selections

Selections over number 20 cannot be programmed with the time edit function.

You cannot edit selections in the following cases:

- If you have programmed up to 32 steps (i.e. selections plus pauses).
- If you have programmed selections whose playing time exceeds 100 minutes.
- If you have programmed a selection number greater than 20.

To specify a different time for each side

Follow steps 1 to 4 and press II. Then repeat steps 2 to 4. Do not follow step 5.

Notes on time edit

- The duration can be set to 99 minutes 59 seconds.
- Playback can be performed when "EDIT" appears.

Fading Out at the Desired Time – Time Fade



You can have play fade out at the end by specifying the play duration. Once the time fade is set, it functions twice for editing both sides of a tape. You can change discs without cancelling this function. The fade time is preset to 5 seconds, but you can change it to last from 2 to 10 seconds (page 12). You cannot use the time fade function when you use the DIGITAL OUT (OPTICAL) connection.

Setting Time Fade and Playing

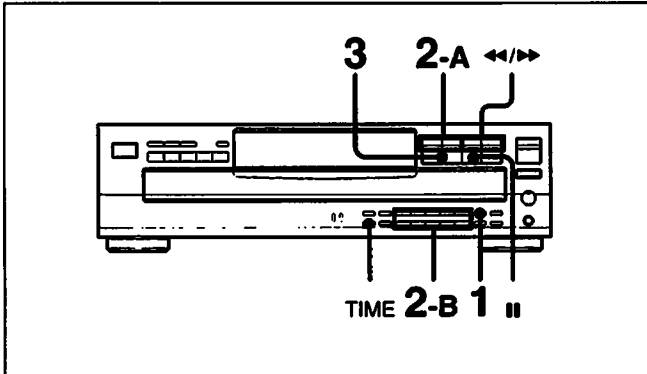

1 Press EDIT/TIME FADE twice during stop (or once during pause).

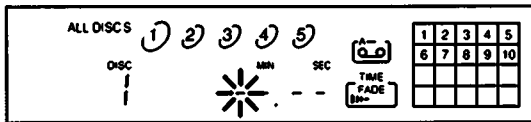

"TIME FADE 5" and "5.00" appear in the display.

2-A Specify a commercially available tape length.

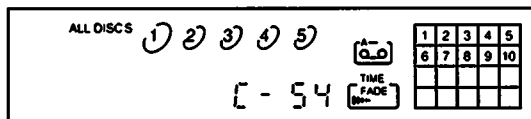
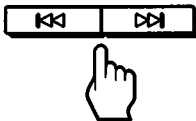

Each time you press ►►, the display changes to give you the following duration:

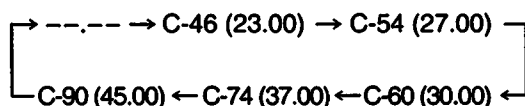

By pressing ◀◀, you can reverse the above cycle.

2-B Specify any tape length for one side of your tape.

Set the desired play duration using numeric buttons.

Example:

To set to 27 minutes 15 seconds, press **2**, **7**, **1** and **5**.

You need not press buttons for seconds, unless required.

Note

The duration can be set to 99 minutes 59 seconds.

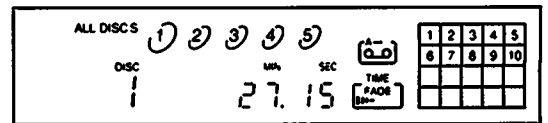
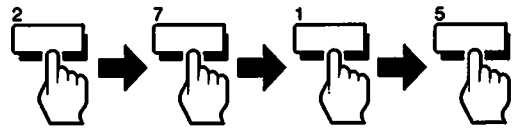

3 Press ►.

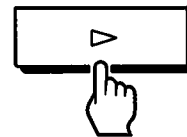

Play starts.

After the specified time, play fades out and pauses. Tape side "B" lights up. Press ► or || to resume playing for the other side of the tape. If you press FADER, fade in will start. When play fades out for the second time, the player pauses and the time fade function is cancelled.

To cancel time fade

Press EDIT/TIME FADE once again, or press ◀◀ or ►► during play.

When a disc ends before the specified time

The time fade function remains effective. You can change discs and continue playing until the specified time is up.

To display the time remaining until the time set

Press TIME during play until the total remaining time appears (page 9).

Storing Selections You Want to Play – Delete Bank



After deleting the selections you do not want to play, you can store the rest of the selections on the disc in memory. This is called a "Delete Bank". You can make one delete bank for each disc. When you play a disc containing a delete bank in continuous or shuffle play mode, the deleted selections are always skipped. In program play mode, you can program an entire disc containing a delete bank in one step. You can store delete banks for up to 400 discs.

Memorizing the Selections You Want to Play

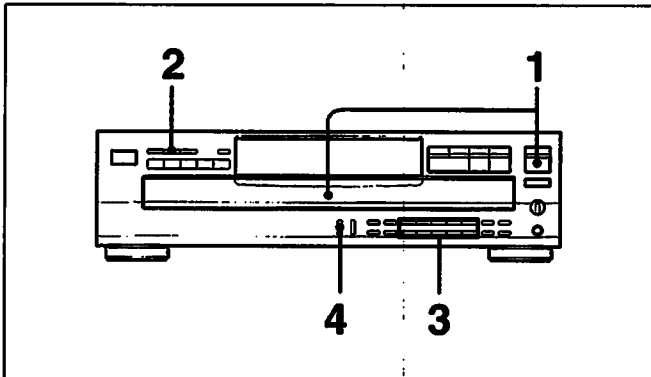

1 Place the discs in the compartments, then press **▲**.

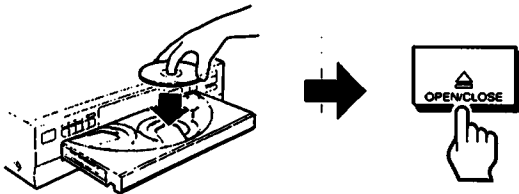

2 Press **SHUFFLE** to choose "ALL DISCS" or "1 DISC".



3 Press the numeric button(s) to delete the selection(s) which you do not want to play.

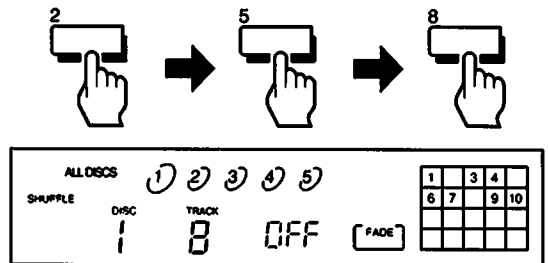

The deleted selection number(s) disappear in the music calendar. To recover a selection which you have deleted, press the numeric button for that selection.

4 Press **FILE**.

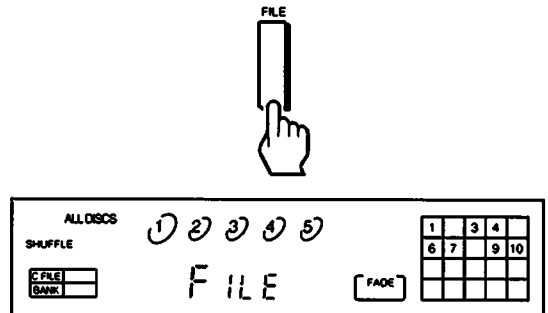

"FILE" and "BANK" appear. The selections are stored in the delete bank.

To change the delete bank

Press the numeric button to recover the selection you deleted, then press FILE.

To recover all the selections you deleted from the current disc.

Hold down CLEAR until "ALL On" appears in the display.

To delete a selection during play

Press the numeric button for the selection. You can also delete the current selection by pressing CLEAR.

Note on the delete bank

Up to 99 selections can be deleted. If no selections are deleted, no delete bank is created.

Storing Selections You Want to Play

Playing the Discs Using a Delete Bank

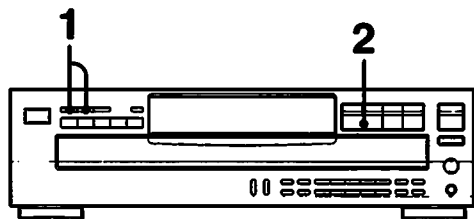

1 Press **CONTINUE** or **SHUFFLE** to choose "ALL DISCS" or "1 DISC".

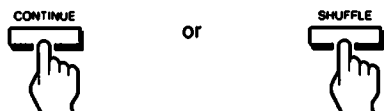

2 Press **▶**.

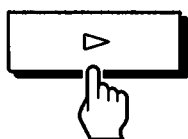

- When you choose "ALL DISCS", the discs in the player are played consecutively. If a disc has a bank, the deleted selections are skipped. If a disc does not have a bank, all the selections on the disc are played.
- If you choose "1 DISC", press DISC 1-5 corresponding to the disc you want to play.
- In program play mode, if you program an entire disc containing a bank, all the selections stored in the bank are programmed in one step.

What is this indication?

 This indication lights up when a delete bank is stored.

Where are delete banks stored?

A delete bank is stored in the player's memory, not in the disc. So you cannot enjoy the delete bank with other players. The delete bank for each disc is recalled when the disc is selected as the current disc and is ready to be played.

Delete banks are retained for approximately 1 month without AC power.

Clearing a Delete Bank

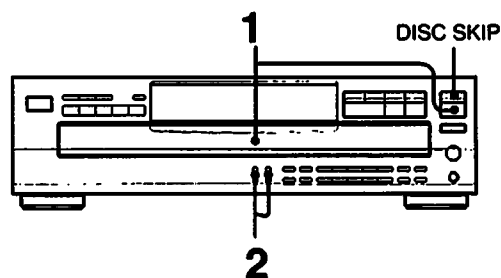

1 Place the disc, containing the delete bank you want to clear, then press **▲** (or select the disc using **DISC SKIP**).

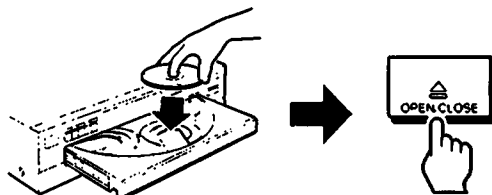

2 Press **FILE**, then press **ERASE** before "FILE" in the display disappears.

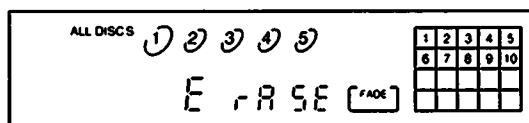
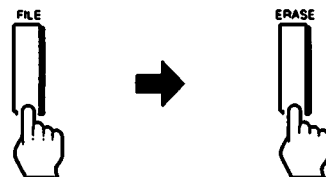

"ErASE" appears and "BANK" disappears. The delete bank is cleared.

When the memory for delete banks is full

"FULL" appears when FILE is pressed and no delete bank can be stored for the new disc in the player. To make a delete bank for the disc, clear a delete bank of another disc.

To clear all delete banks of all discs

While holding down ERASE and FILE, press POWER to turn on the player. "ALL ErS" appears in the display.

Maintenance

Cleaning Your Player

Clean the cabinet, panel and controls with a soft cloth lightly moistened with a mild detergent solution. Do not use any type of abrasive pad, scouring powder or solvent such as alcohol or benzene.

Cleaning Discs

When a disc becomes dirty, clean it with a cleaning cloth. Wipe the disc from the center out.

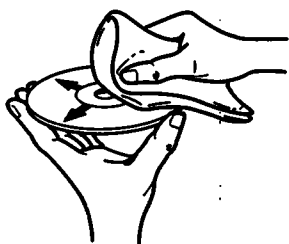

Do not use solvents such as benzene, thinner, commercially available cleaners or anti-static spray intended for analog discs.

Specifications

Compact Disc Player

System	Compact disc digital audio system
Laser	Semiconductor laser
Wavelength	780–790 nm
Frequency response	2 Hz–20 kHz (± 0.5 dB)
Signal to noise ratio	More than 107 dB
Dynamic range	More than 98 dB
Harmonic distortion	Less than 0.0035%
Channel separation	More than 100 dB

Outputs

LINE OUT (phono jacks)	Output level 2 V Load impedance over 10 kilohms
DIGITAL OUT (OPTICAL) (optical output connector)	Wave length 660 nm Output level –18 dBm
PHONES (stereo phone jack)	Output level max. 10 mW Load impedance 32 ohms

General

Power requirements	Model for the USA and Canada 120 V AC, 60 Hz Model for Australia 240V AC, 50/60 Hz
Power consumption	14 W
Dimensions (approx.)	430 × 125 × 385 mm (w/h/d) (17 × 5 × 15 ¹ / ₄ inches) Including projecting parts and controls
Mass (approx.)	5.7 kg , net (12 lbs 10oz)

Remote Commander	RM-D335
Remote control system	Infrared control
Power requirements	3 V DC with two size AA batteries (IEC designation R6)
Dimensions	45 × 20 × 185 mm (w/h/d) (1 ¹³ / ₁₆ × 1 ³ / ₁₆ × 7 ³ / ₈ inches)
Mass	100 g (3.5 oz) including batteries

Design and specifications are subject to change without notice.

Troubleshooting

Before going through the check list below, first refer back to the applicable connections and operating procedures. Should problem persist after you have checked these items, consult your nearest Sony service facility.

Symptom	Cause	Remedy
The disc tray does not close.	The disc is not placed correctly.	Place the disc correctly on the disc tray.
Play does not start.	The disc is dirty.	Clean the disc.
	The disc is inserted upside down.	Insert the disc with the printed side up.
	The player is in pause mode.	Press ► or to release pause.
	Moisture has condensed.	Leave the player on for approximately one hour.
"no disc" appears.	There is no disc in the player.	Insert a disc.
"5 discs" appears.	Six discs are inserted.	Remove a disc from the disc tray.
No sound is heard.	There is a loose connection.	Insert the plug firmly.
	The connection is incorrect.	Check the connection referring to "Hooking up the system".
Play does not begin from the first selection.	The player is in program or shuffle play mode.	Press CONTINUE.
Two or more discs cannot be played consecutively.	The player is in the 1 DISC mode.	Press CONTINUE to choose ALL DISCS mode.
"⏮" is displayed.	▶▶ was continuously pressed at the end of the disc.	Press ◀◀ or ◀◀ to return to the normal indication.
The remote commander does not operate the player.	The batteries are run down.	Replace both batteries.
	The remote commander is not pointed at the remote sensor.	Point the remote commander at the sensor.
	There is an obstacle between the remote commander and the player.	Remove the obstacle.
	The remote commander is too far from the player.	Move it closer.

Note

This unit uses several micro-computer chips to control a series of operations. Sometimes, an operation may not work properly due to the condition of the power being supplied. In this case, turn the power off, then turn it back on and retry the operation.